

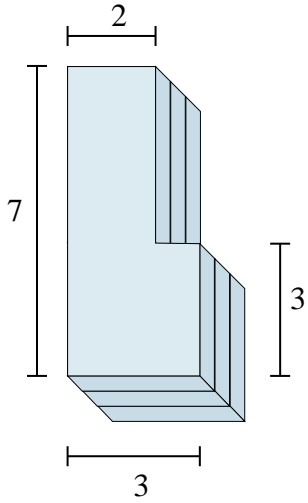

Find the total volume of each figure shown. Measured in cm (not to scale).

Answers

1)



2)

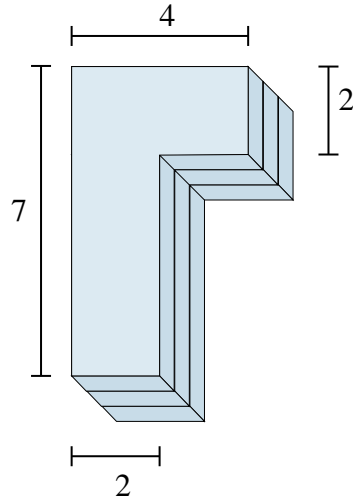

1. _____

2. _____

3. _____

4. _____

5. _____

6. _____

3)

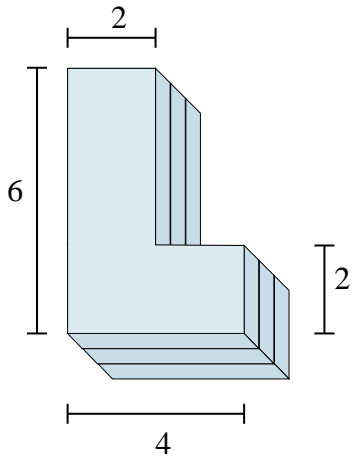

4)

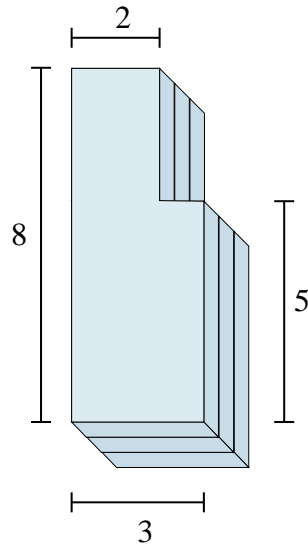

5)

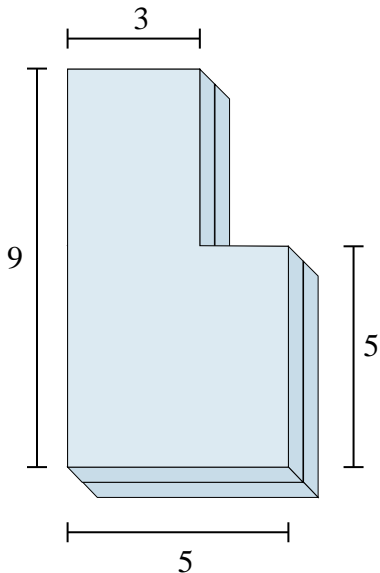

6)

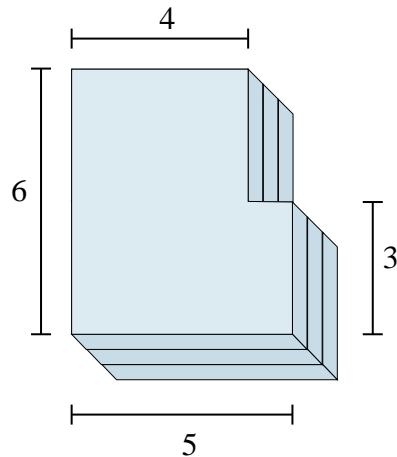



Find the total volume of each figure shown. Measured in cm (not to scale).

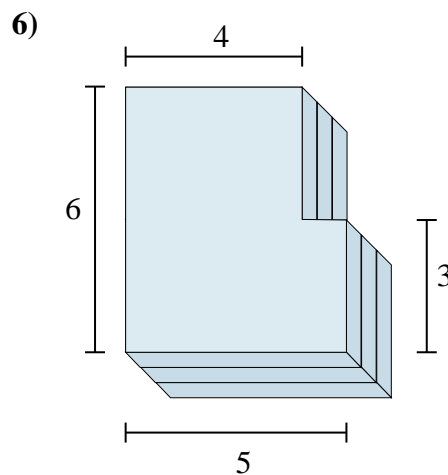
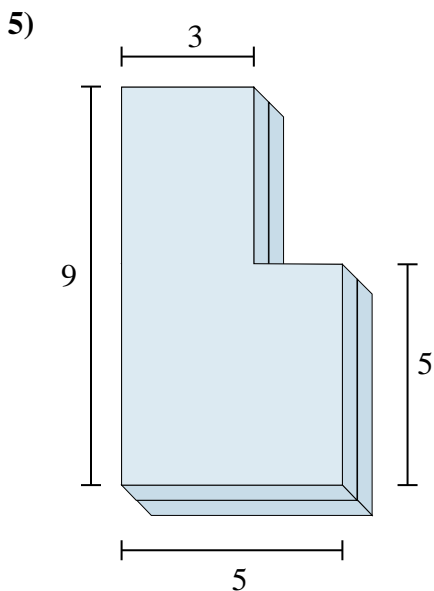
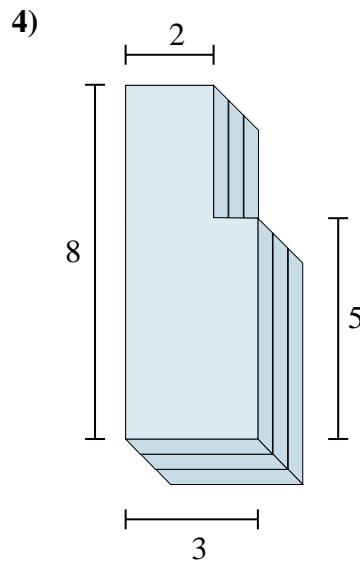
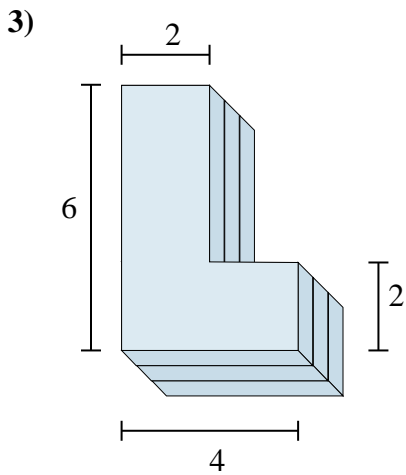
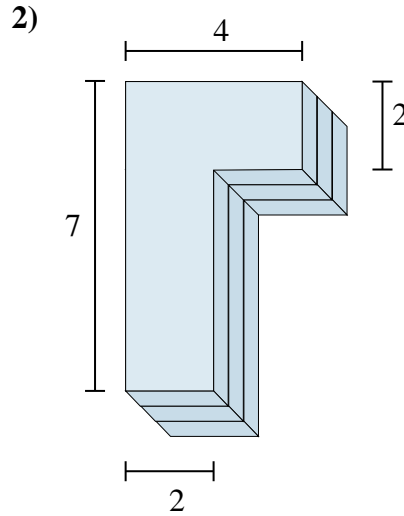
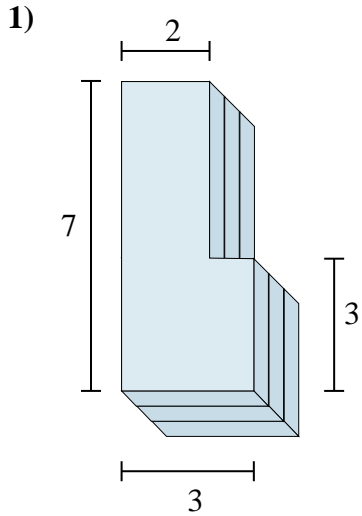

Answers

1. 51 cm³
2. 54 cm³
3. 48 cm³
4. 63 cm³
5. 74 cm³
6. 81 cm³



Find the total volume of each figure shown. Measured in cm (not to scale).

Answers

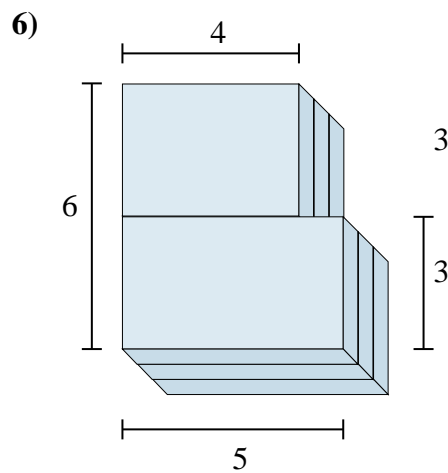
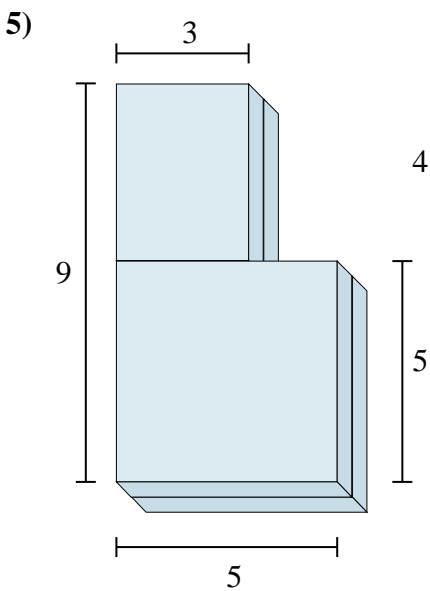
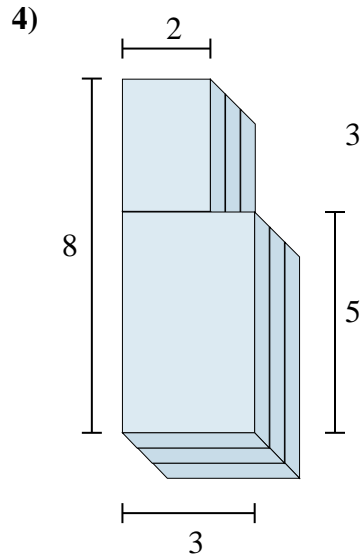
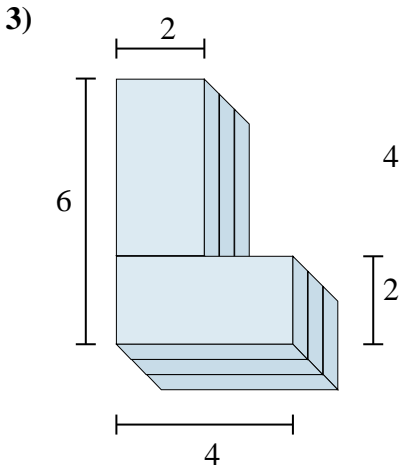
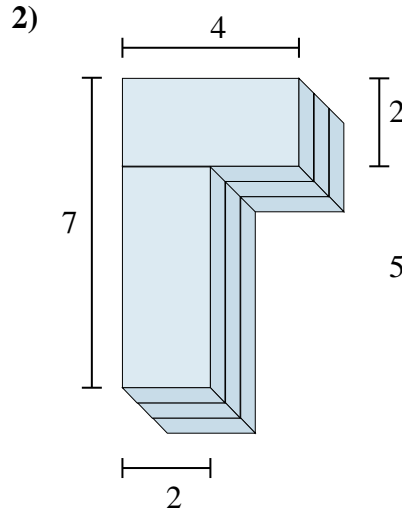
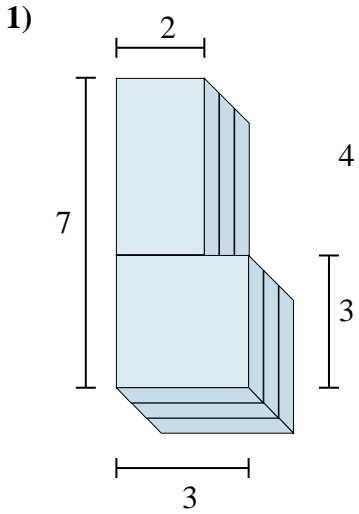

1. _____
2. _____
3. _____
4. _____
5. _____
6. _____