

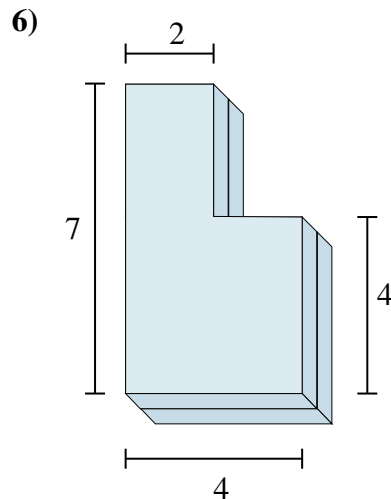

Find the total volume of each figure shown. Measured in cm (not to scale).

Answers

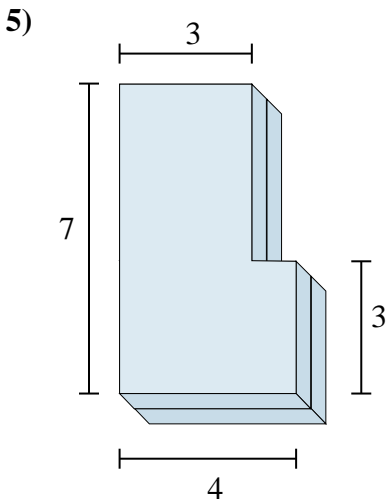
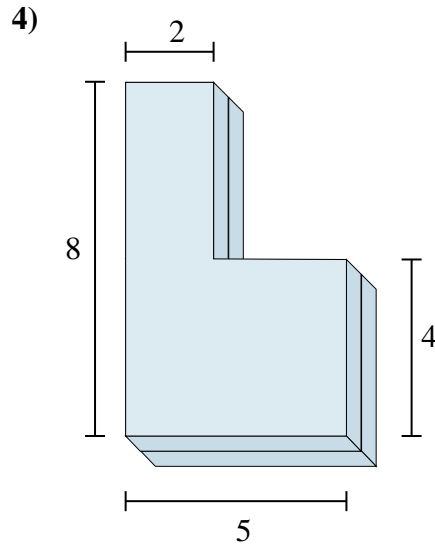
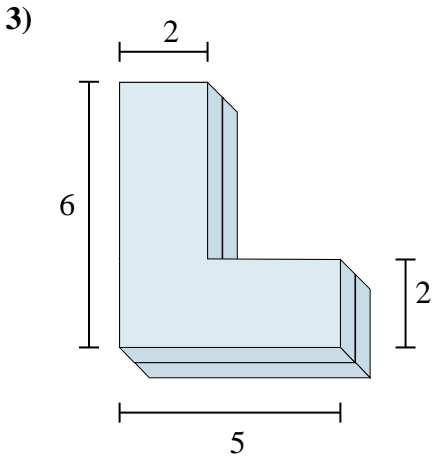
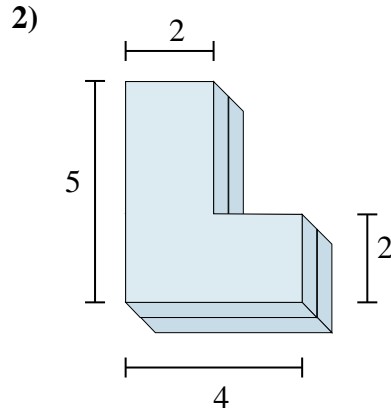
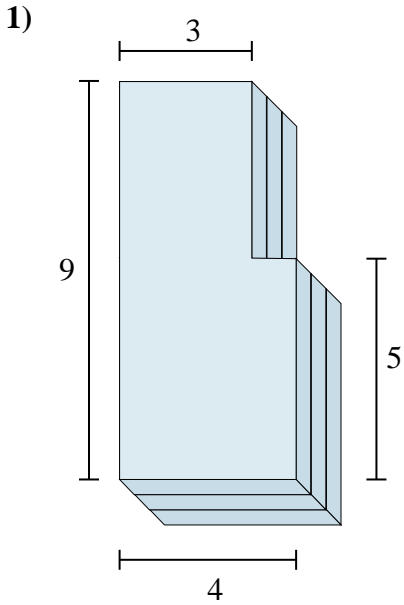

1. _____
2. _____
3. _____
4. _____
5. _____
6. _____



Find the total volume of each figure shown. Measured in cm (not to scale).

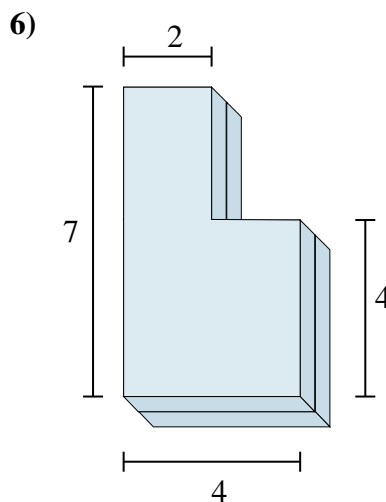
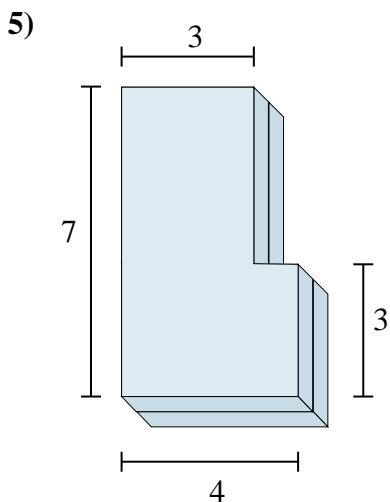
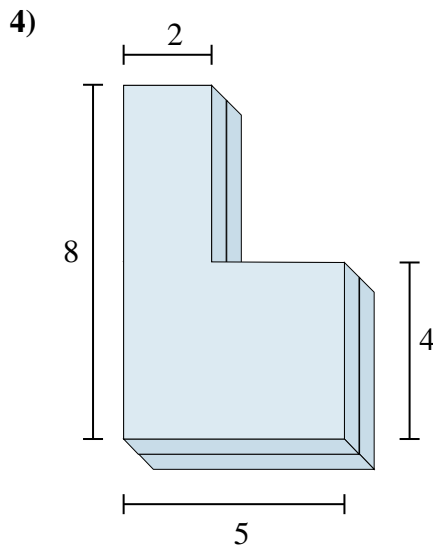
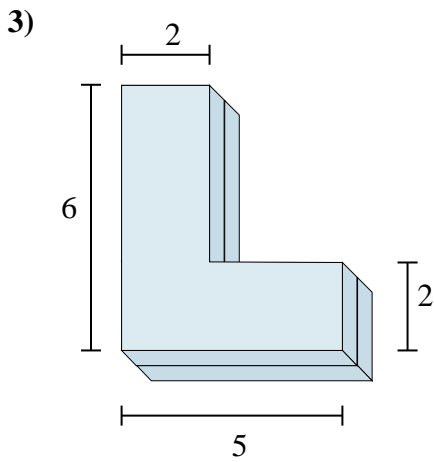
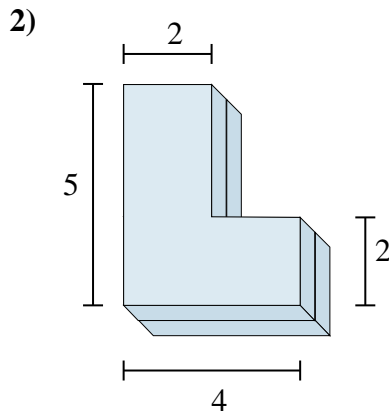
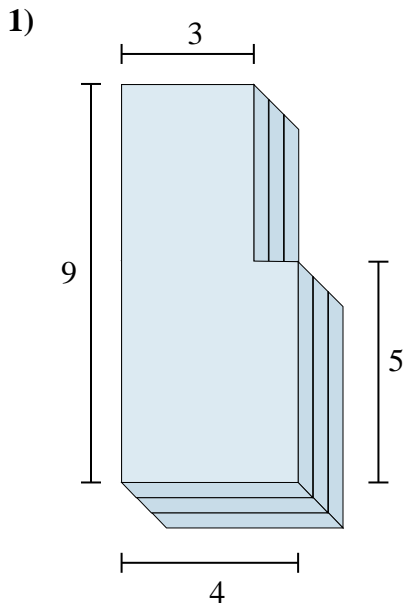

Answers

1. **96 cm³**

2. **28 cm³**

3. **36 cm³**

4. **56 cm³**

5. **48 cm³**

6. **44 cm³**



Find the total volume of each figure shown. Measured in cm (not to scale).

Answers

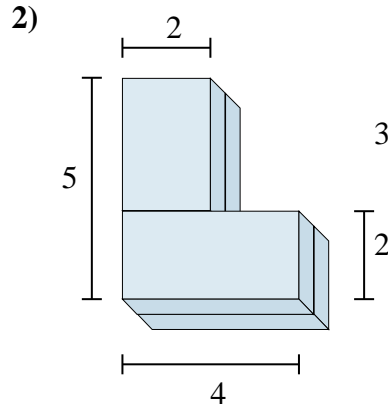
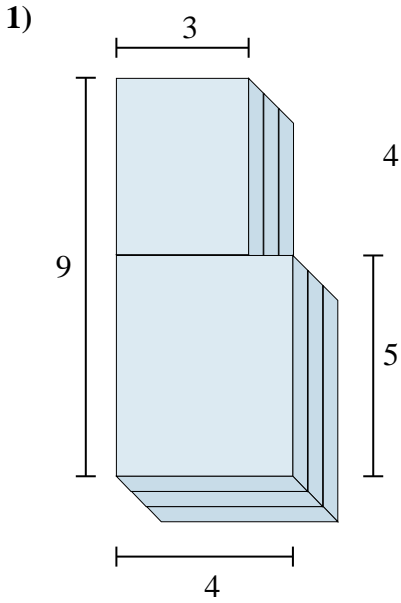

1. _____

2. _____

3. _____

4. _____

5. _____

6. _____

