

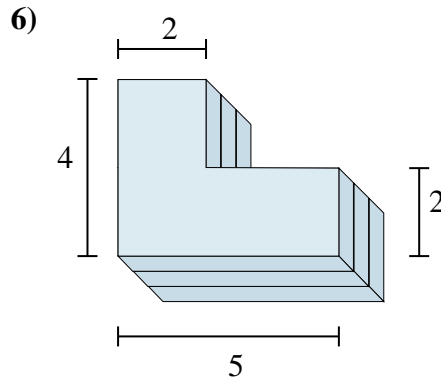

Find the total volume of each figure shown. Measured in cm (not to scale).

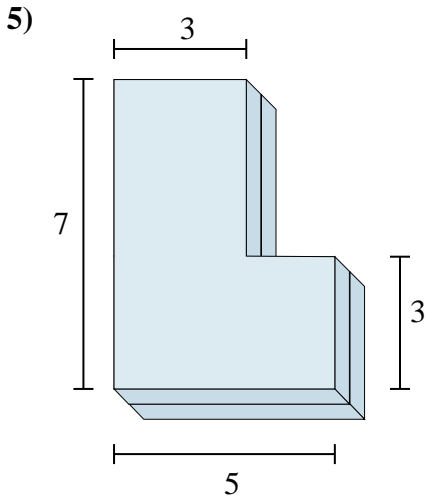
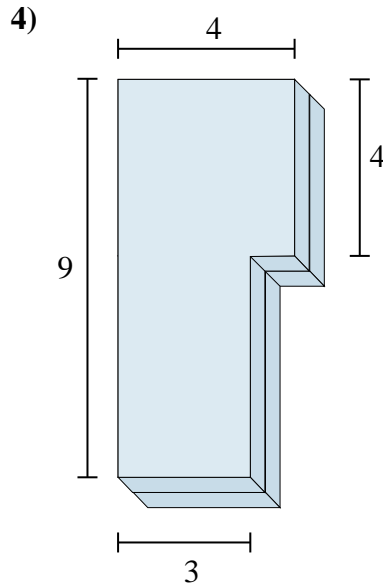
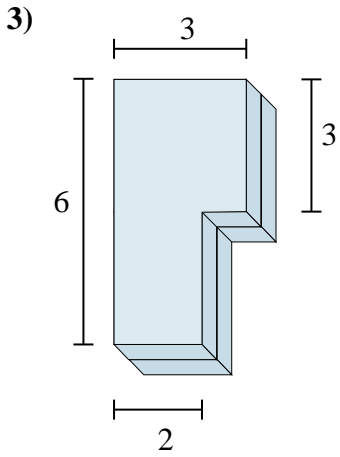
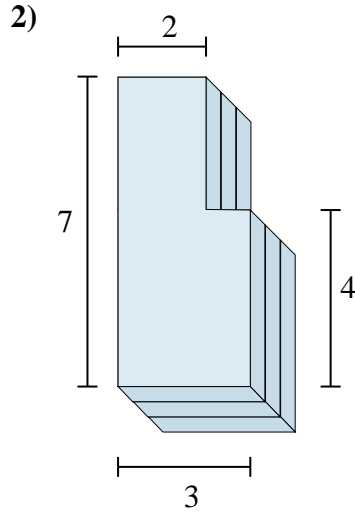
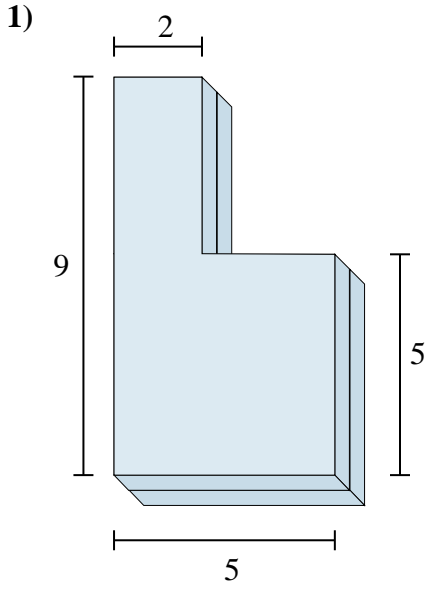

Answers

1. _____

2. _____

3. _____

4. _____

5. _____

6. _____



Find the total volume of each figure shown. Measured in cm (not to scale).

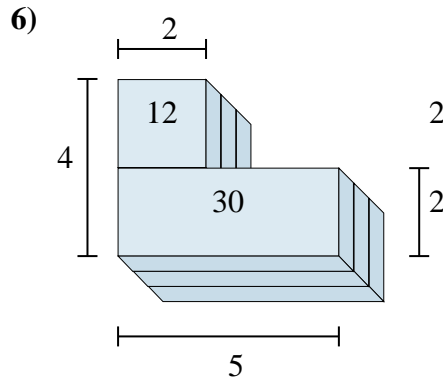
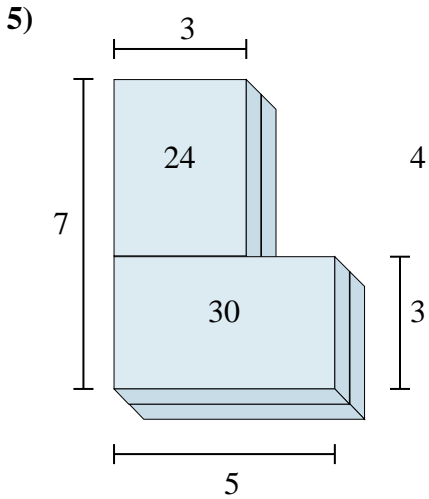
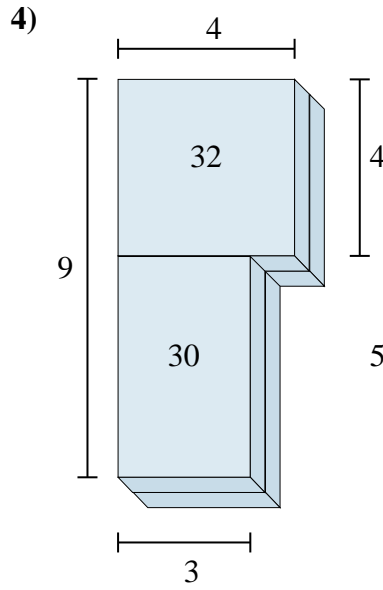
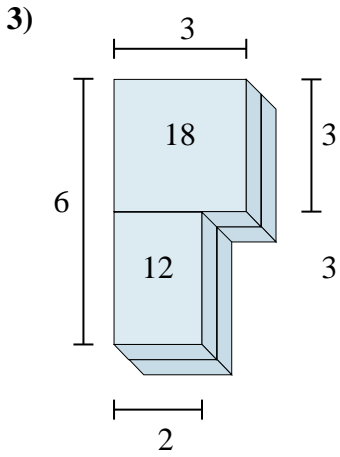
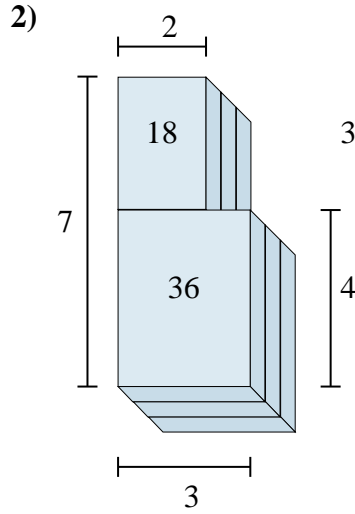
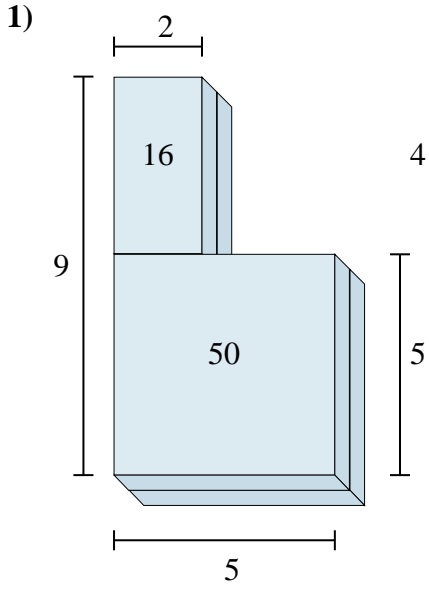

Answers

1. 66 cm³

2. 54 cm³

3. 30 cm³

4. 62 cm³

5. 54 cm³

6. 42 cm³



Find the total volume of each figure shown. Measured in cm (not to scale).

Answers

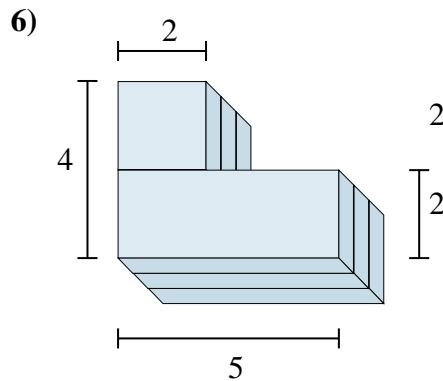
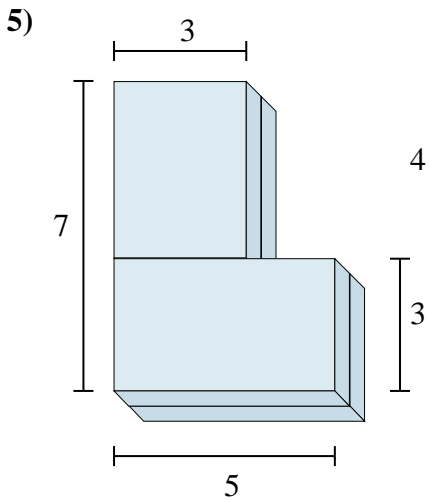
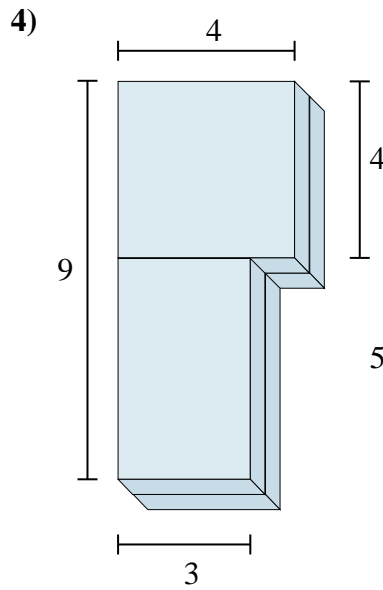
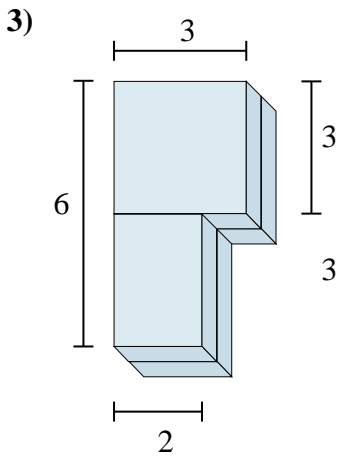
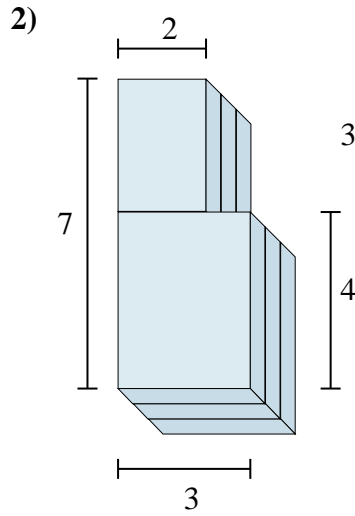
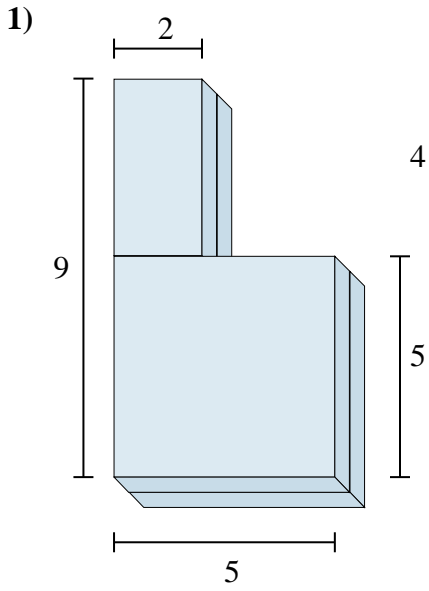

1. _____
2. _____
3. _____
4. _____
5. _____
6. _____