

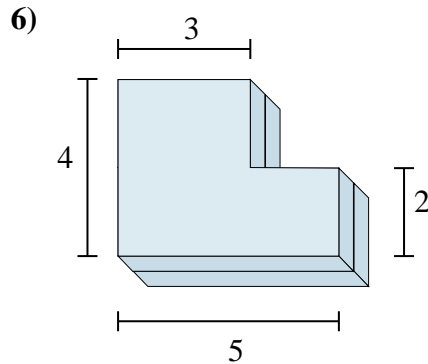

Find the total volume of each figure shown. Measured in cm (not to scale).

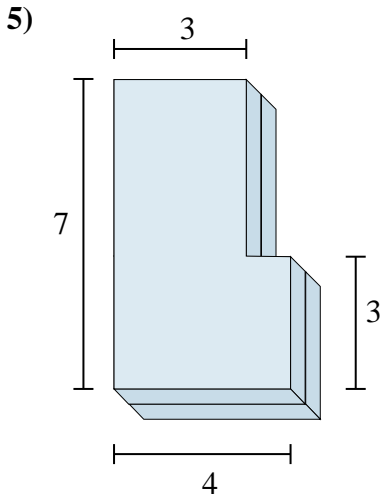
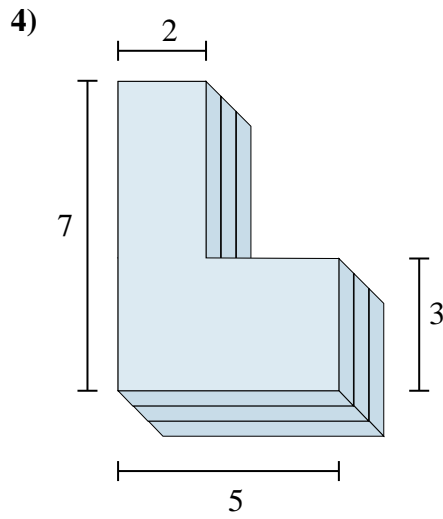
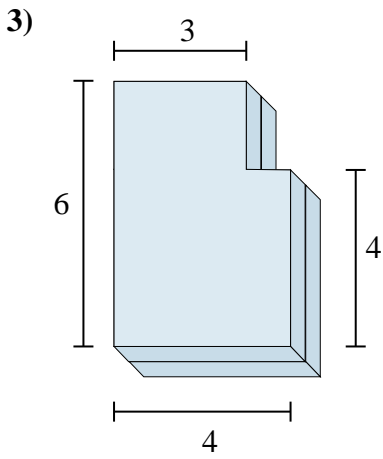
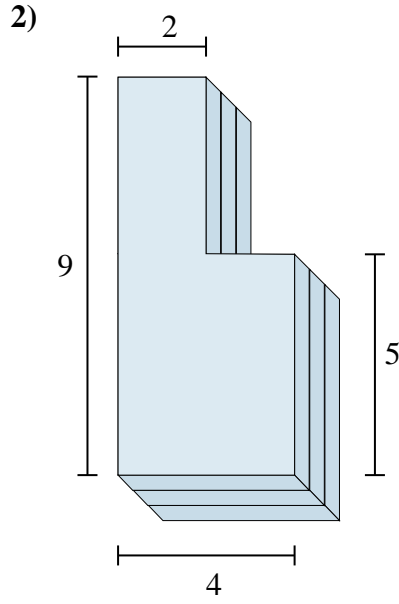
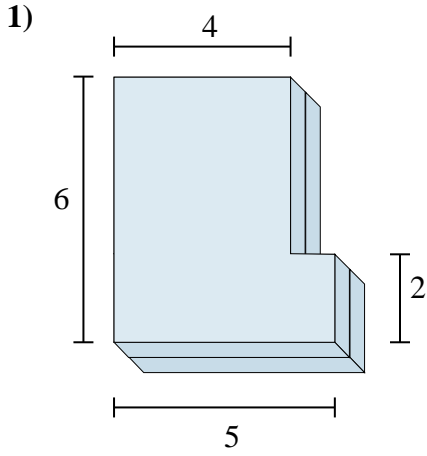

Answers

1. _____

2. _____

3. _____

4. _____

5. _____

6. _____



Find the total volume of each figure shown. Measured in cm (not to scale).

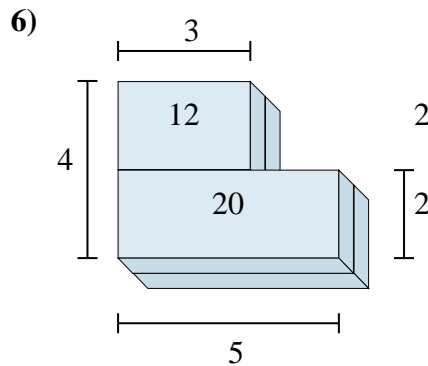
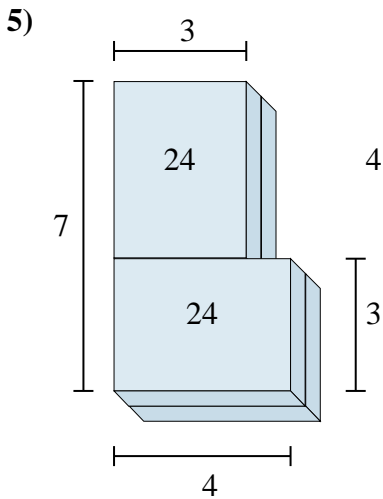
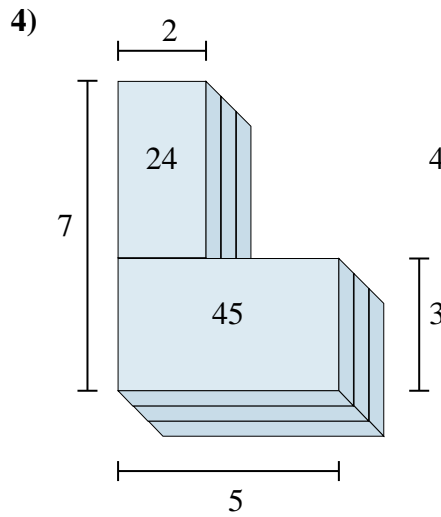
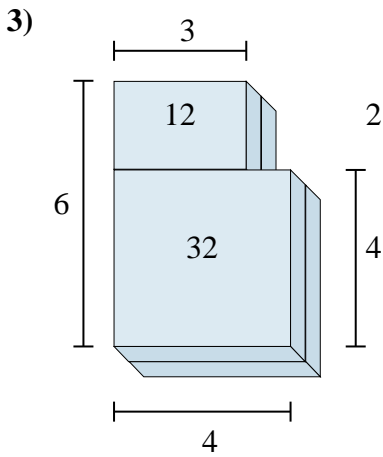
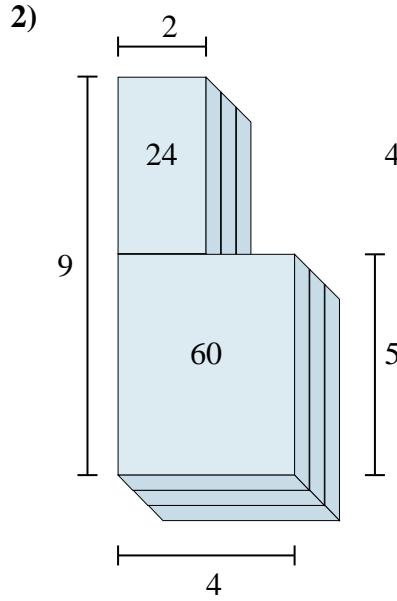
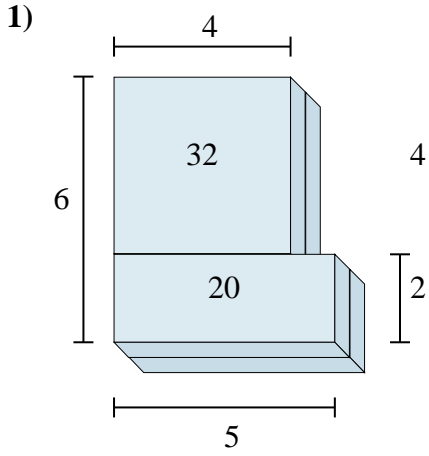

Answers

1. 52 cm³

2. 84 cm³

3. 44 cm³

4. 69 cm³

5. 48 cm³

6. 32 cm³



Find the total volume of each figure shown. Measured in cm (not to scale).

Answers

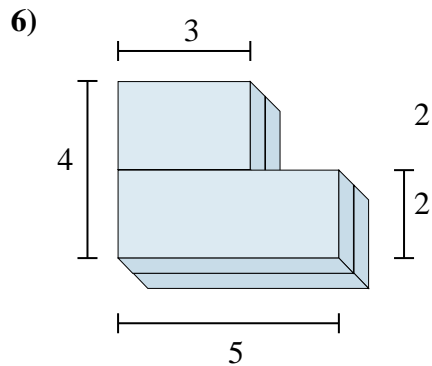
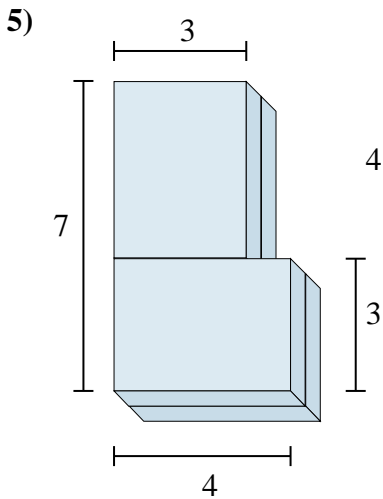
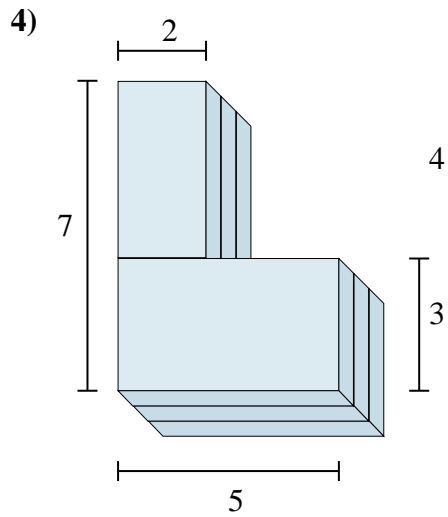
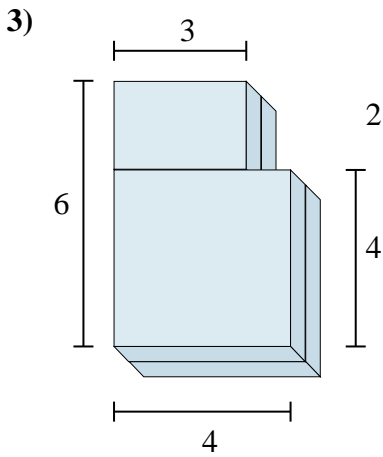
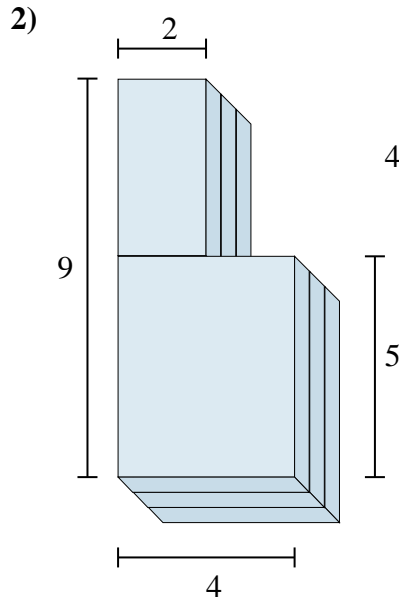
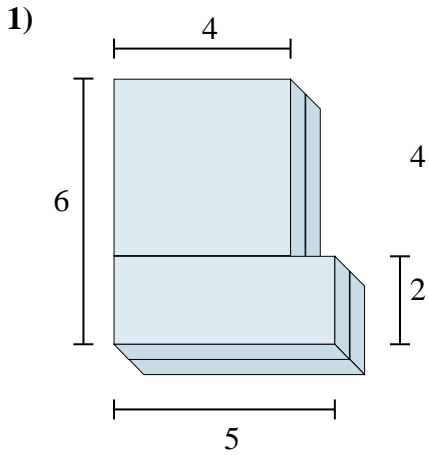

1. _____
2. _____
3. _____
4. _____
5. _____
6. _____