

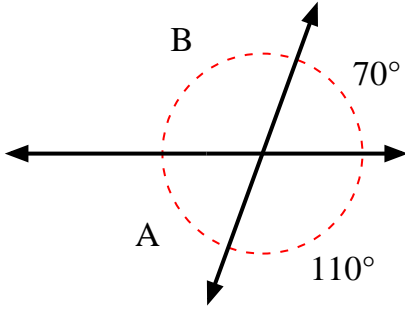

Find the value of angle 'A' and angle 'B'.

1)



2)

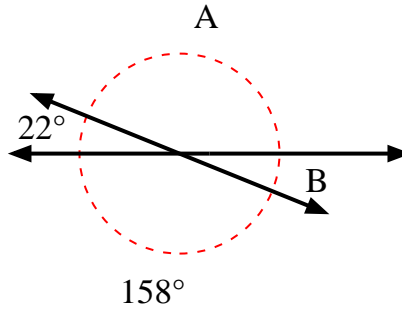

3)

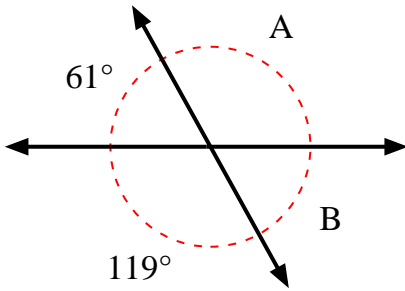

4)

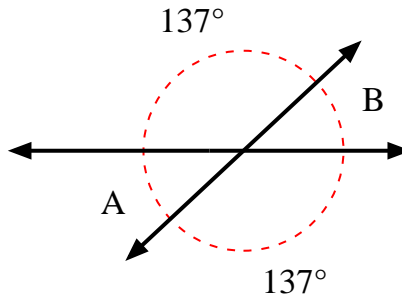

5)

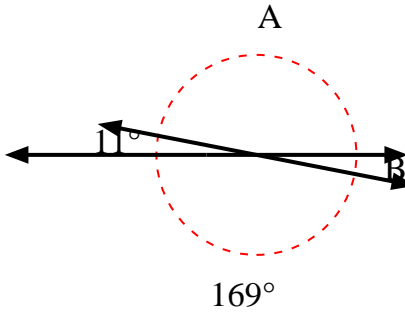

6)

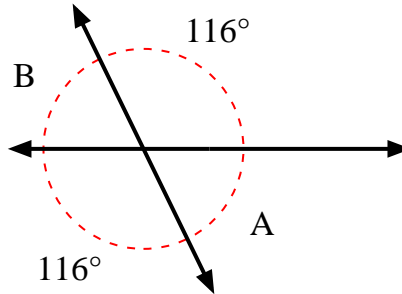

7)

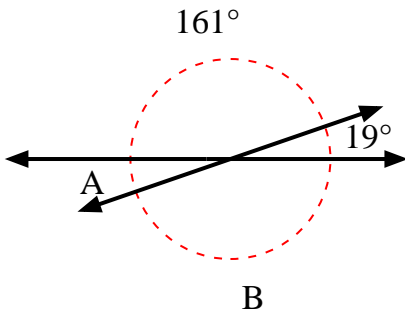

8)

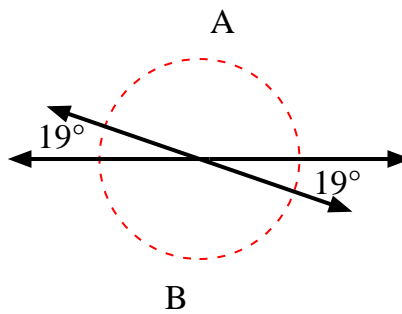

Answers

1. \_\_\_\_\_
2. \_\_\_\_\_
3. \_\_\_\_\_
4. \_\_\_\_\_
5. \_\_\_\_\_
6. \_\_\_\_\_
7. \_\_\_\_\_
8. \_\_\_\_\_



Find the value of angle 'A' and angle 'B'.

1)

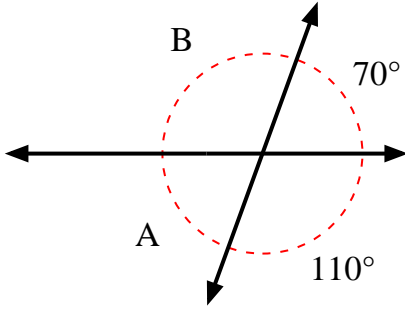

2)

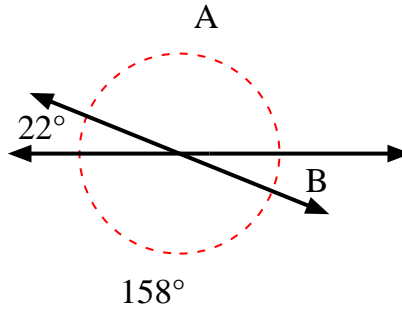

3)

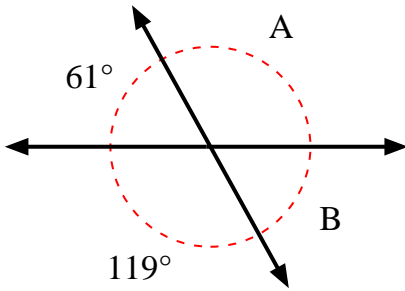

4)

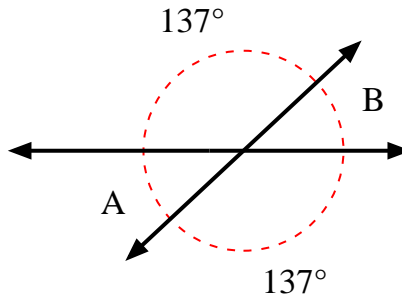

5)

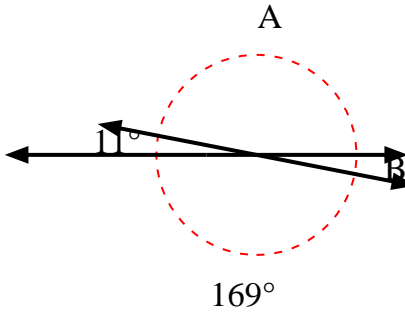

6)

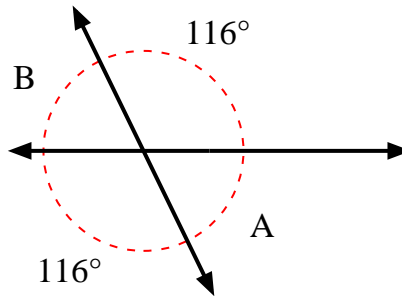

7)

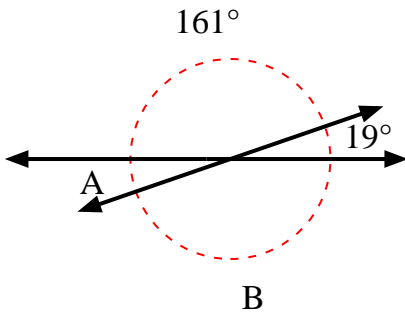

8)

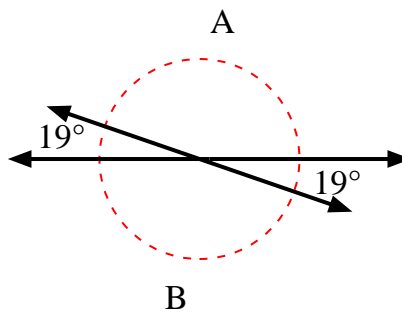

Answers

1. 70°    110°
2. 158°    22°
3. 119°    61°
4. 43°    43°
5. 169°    11°
6. 64°    64°
7. 19°    161°
8. 161°    161°