

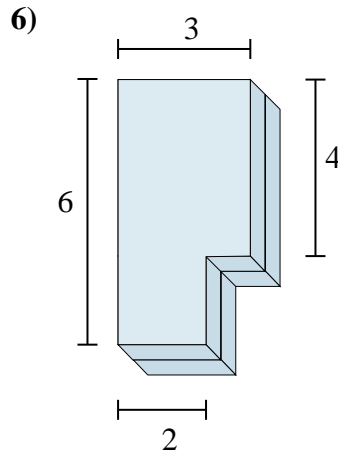

Find the total volume of each figure shown. Measured in cm (not to scale).

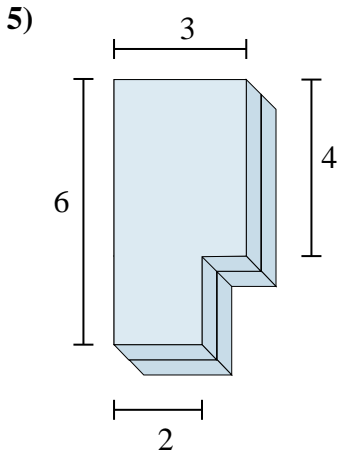
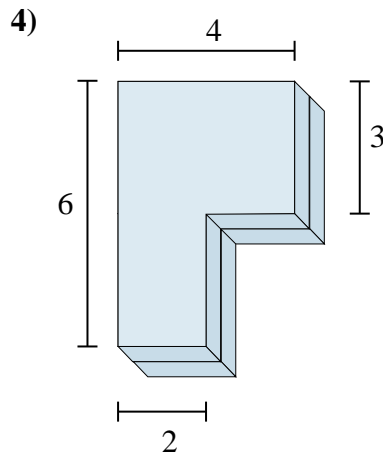
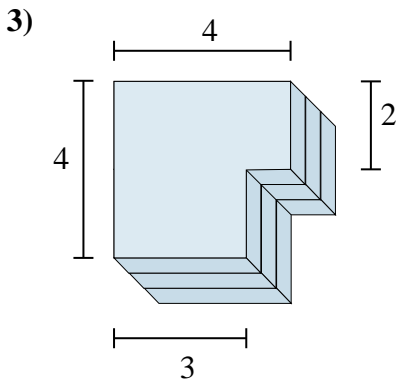
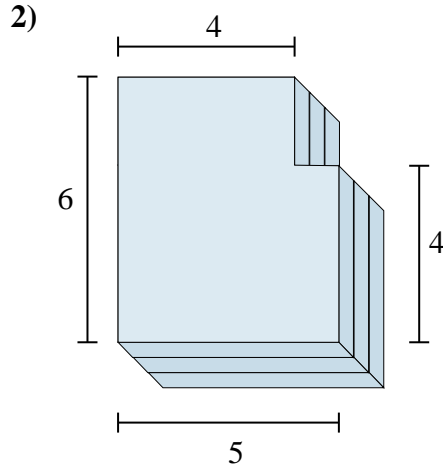
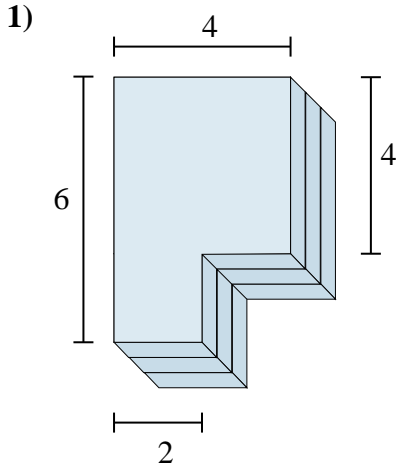

Answers

1. \_\_\_\_\_

2. \_\_\_\_\_

3. \_\_\_\_\_

4. \_\_\_\_\_

5. \_\_\_\_\_

6. \_\_\_\_\_



Find the total volume of each figure shown. Measured in cm (not to scale).

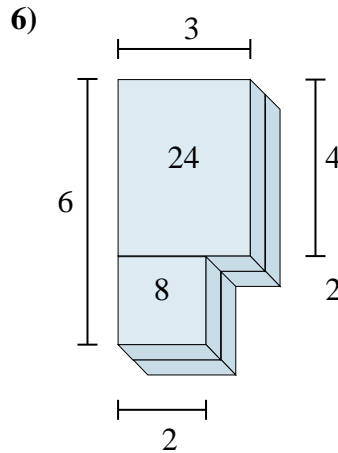
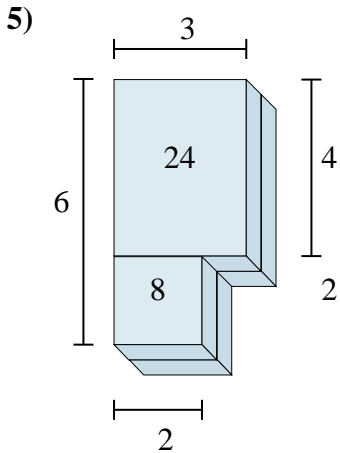
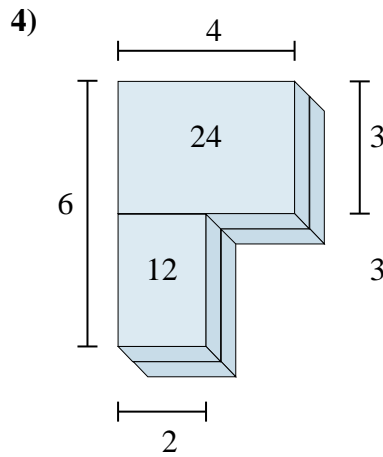
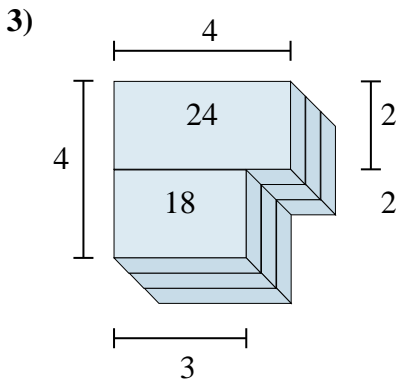
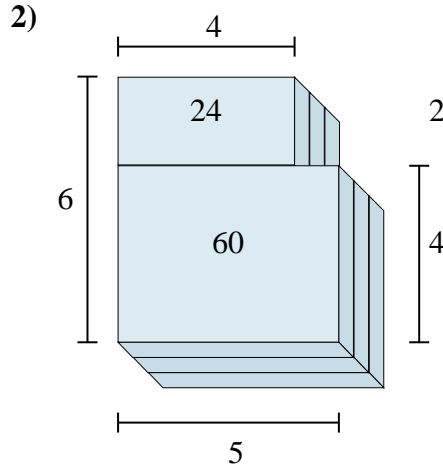
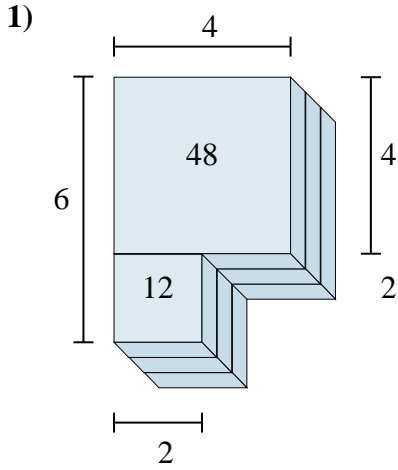

Answers

1. 60 cm<sup>3</sup>

2. 84 cm<sup>3</sup>

3. 42 cm<sup>3</sup>

4. 36 cm<sup>3</sup>

5. 32 cm<sup>3</sup>

6. 32 cm<sup>3</sup>



Find the total volume of each figure shown. Measured in cm (not to scale).

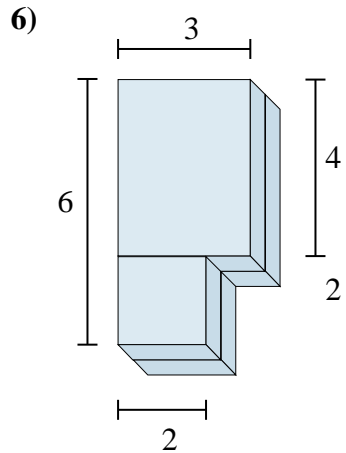
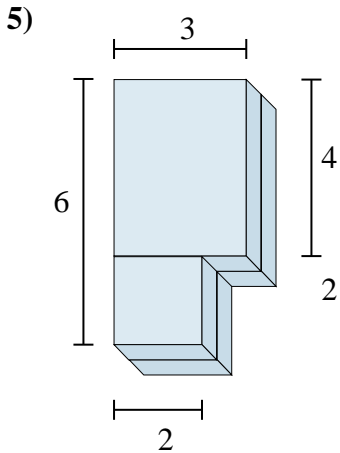
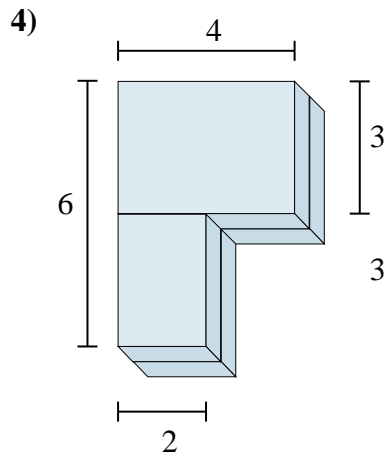
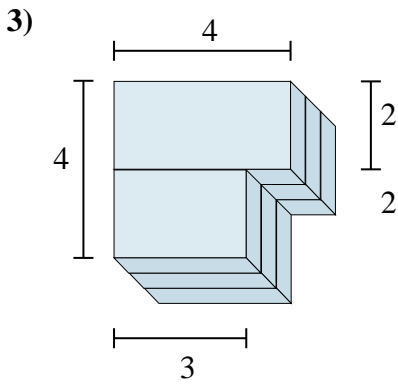
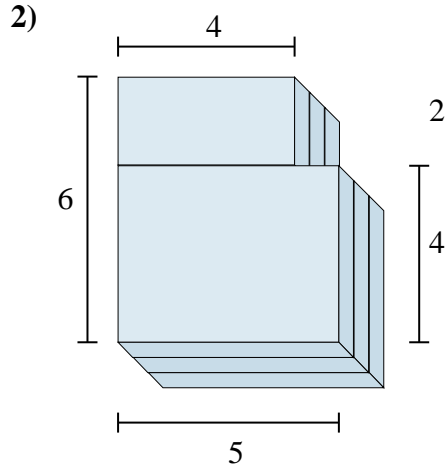
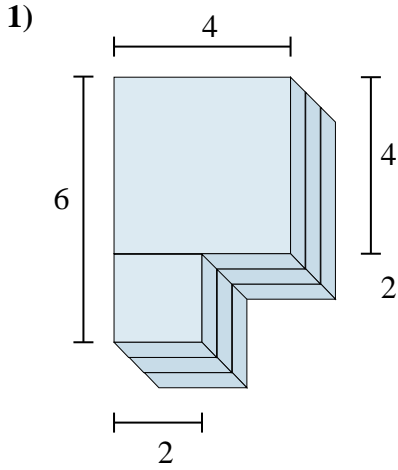

Answers

1. \_\_\_\_\_

2. \_\_\_\_\_

3. \_\_\_\_\_

4. \_\_\_\_\_

5. \_\_\_\_\_

6. \_\_\_\_\_