

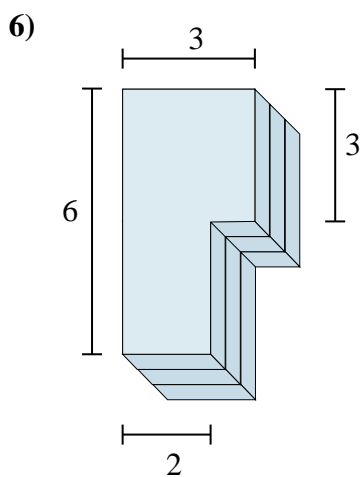

Find the total volume of each figure shown. Measured in cm (not to scale).

Answers

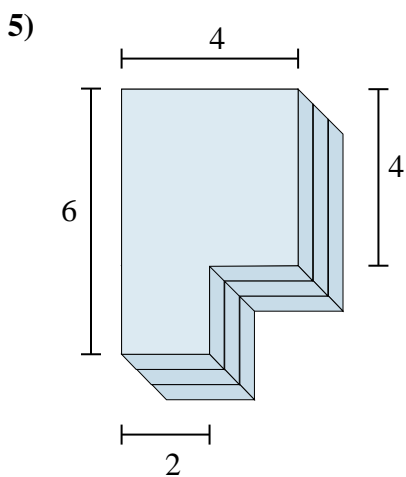
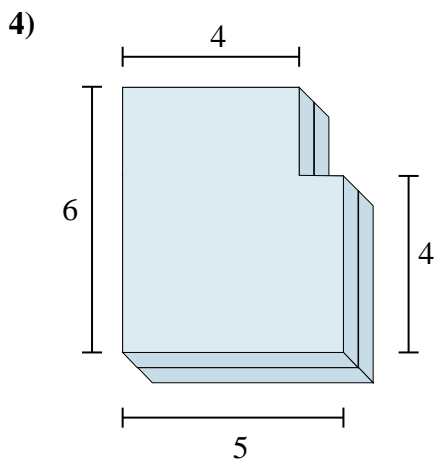
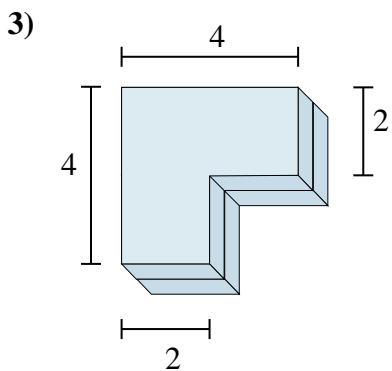
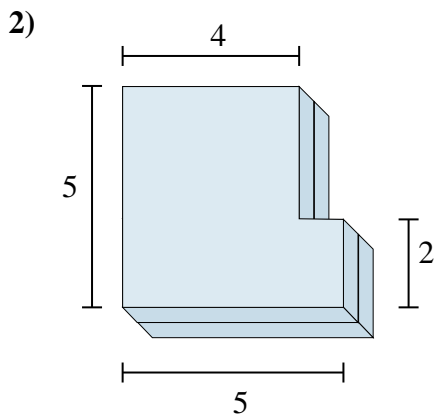
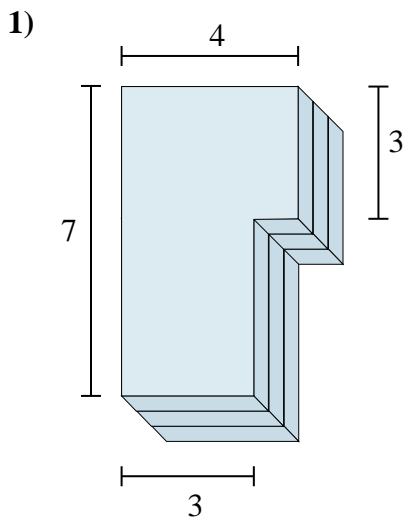

- 1. \_\_\_\_\_
- 2. \_\_\_\_\_
- 3. \_\_\_\_\_
- 4. \_\_\_\_\_
- 5. \_\_\_\_\_
- 6. \_\_\_\_\_



Find the total volume of each figure shown. Measured in cm (not to scale).

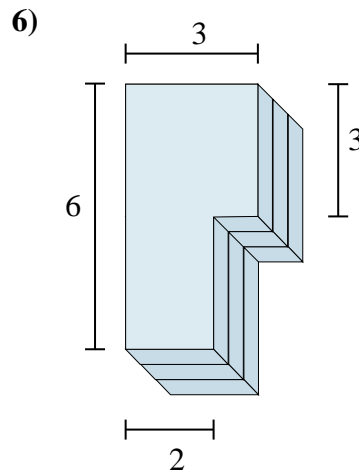
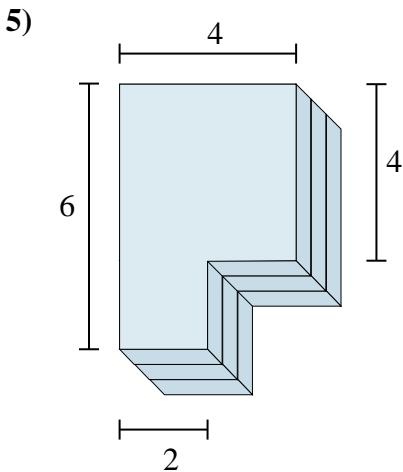
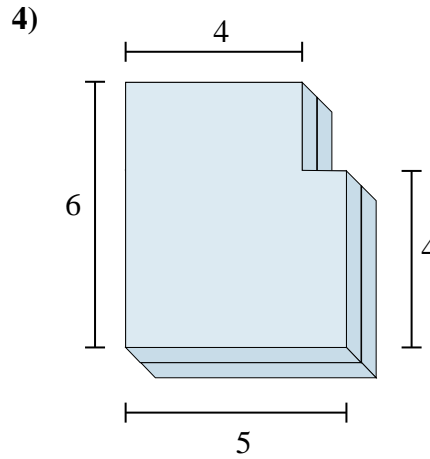
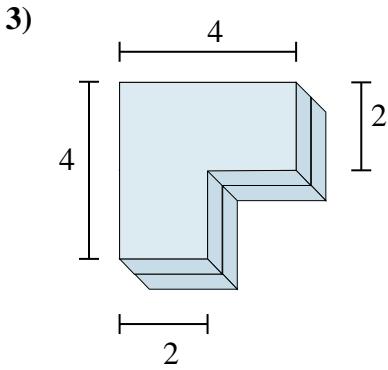
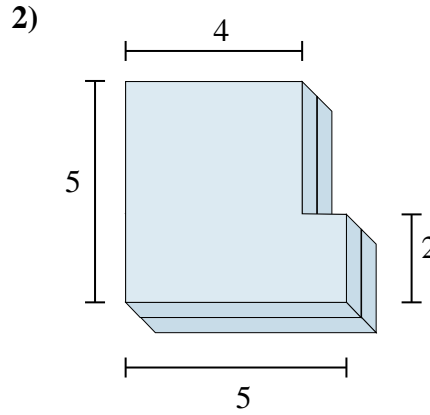
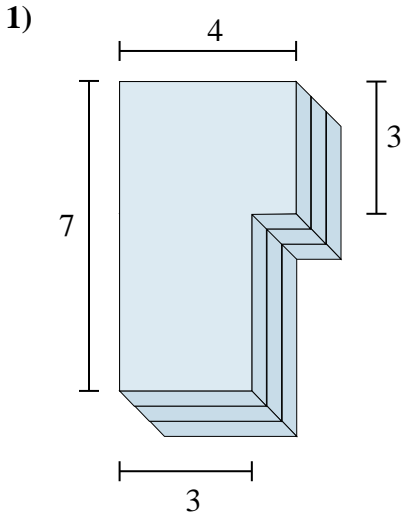

Answers

1. **72 cm<sup>3</sup>**

2. **44 cm<sup>3</sup>**

3. **24 cm<sup>3</sup>**

4. **56 cm<sup>3</sup>**

5. **60 cm<sup>3</sup>**

6. **45 cm<sup>3</sup>**



Find the total volume of each figure shown. Measured in cm (not to scale).

Answers

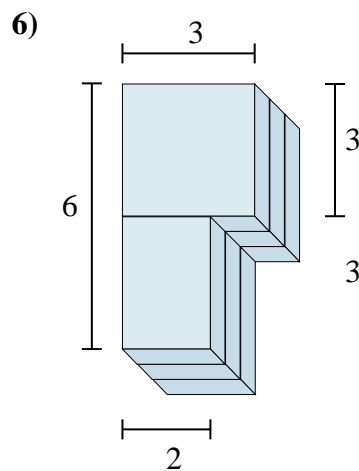
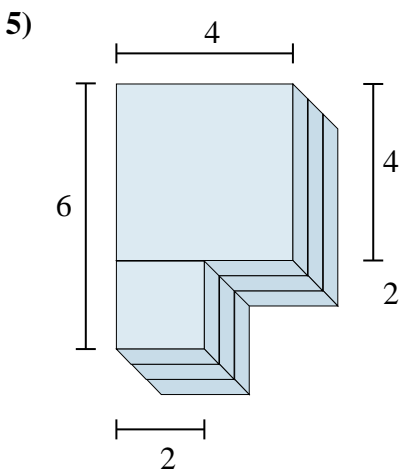
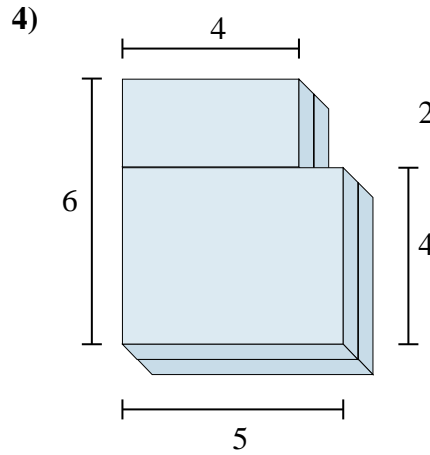
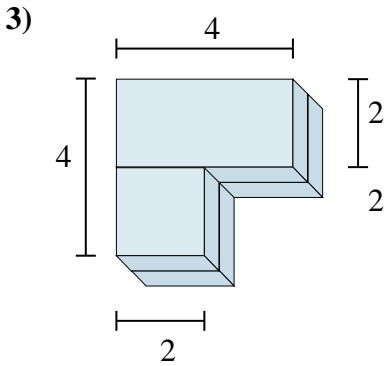
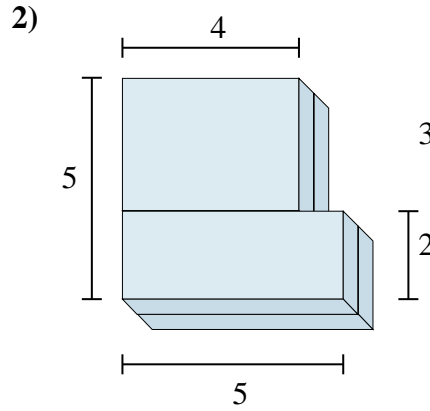
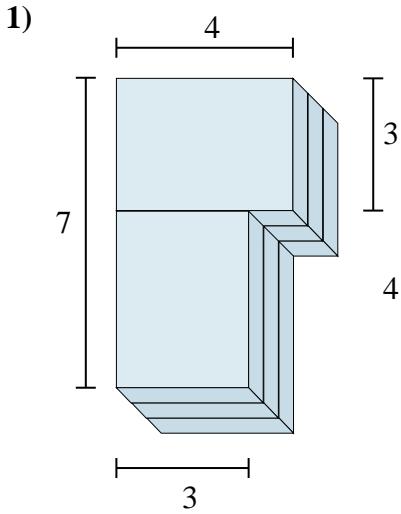

1. \_\_\_\_\_
2. \_\_\_\_\_
3. \_\_\_\_\_
4. \_\_\_\_\_
5. \_\_\_\_\_
6. \_\_\_\_\_