

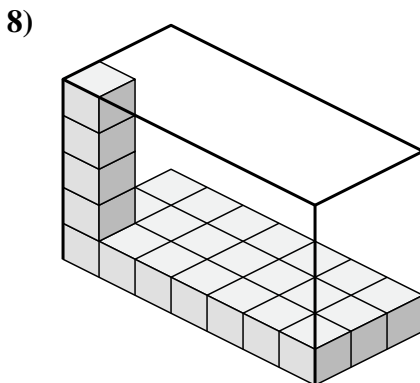

Determine the volume of each box. Each block is 1 cubic unit (u³).

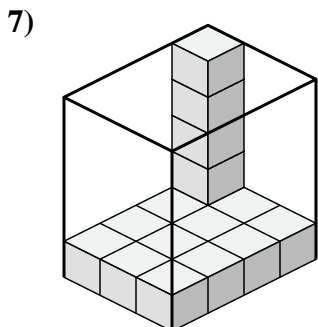
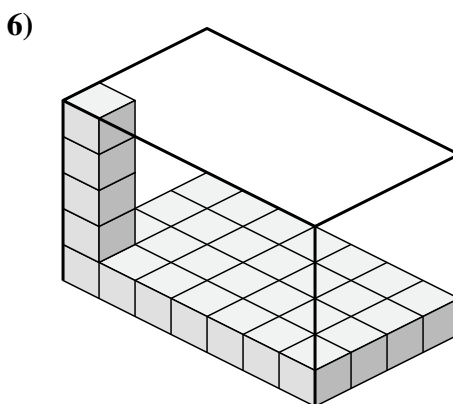
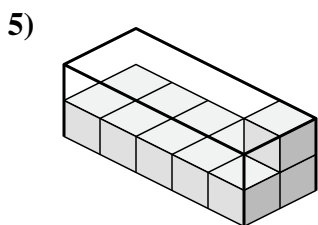
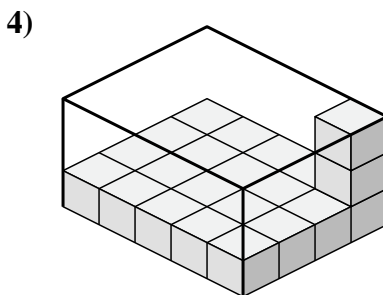
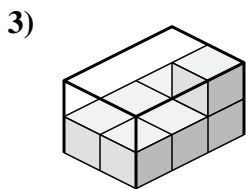
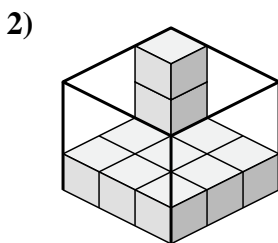
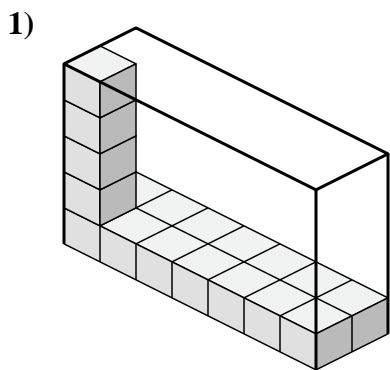

Answers

1. _____

2. _____

3. _____

4. _____

5. _____

6. _____

7. _____

8. _____



Determine the volume of each box. Each block is 1 cubic unit (u^3).

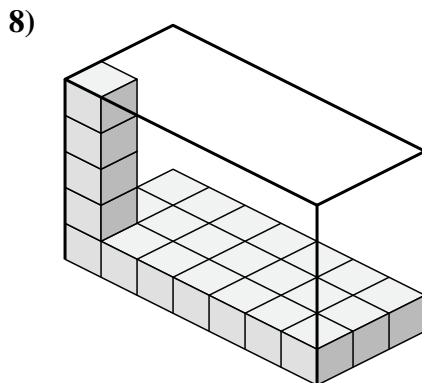
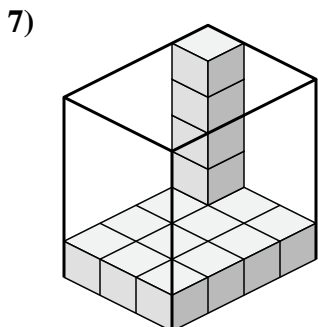
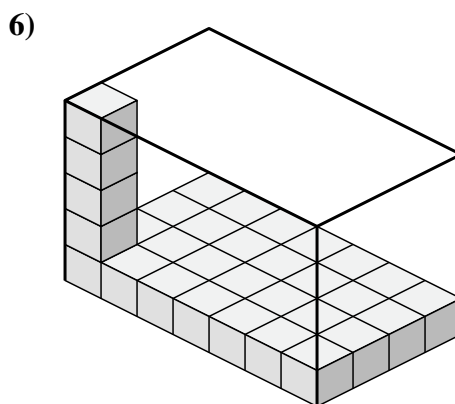
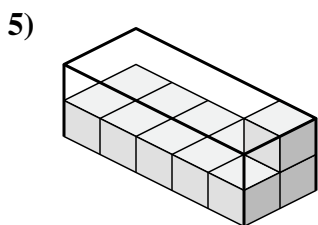
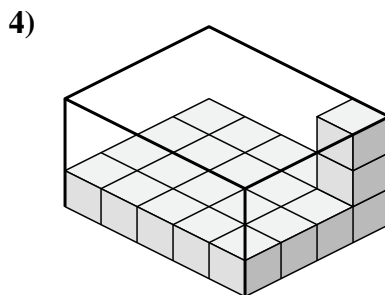
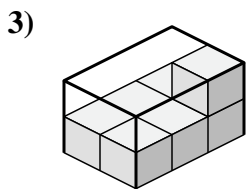
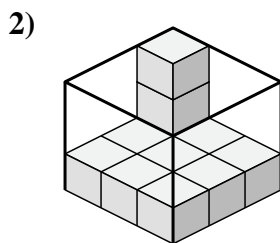
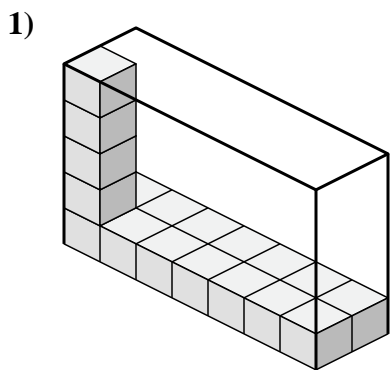

Answers

1. 70 u^3

2. 27 u^3

3. 12 u^3

4. 60 u^3

5. 20 u^3

6. 140 u^3

7. 60 u^3

8. 105 u^3