

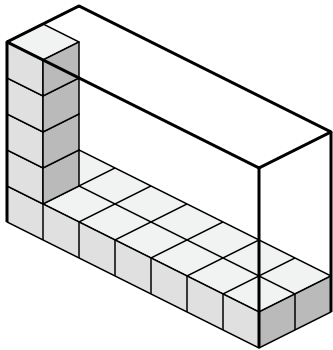

Create an expression to determine the volume of each box.

1)



2)

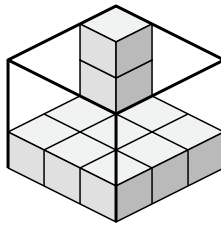

3)

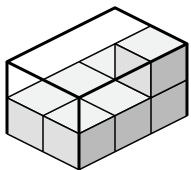

4)

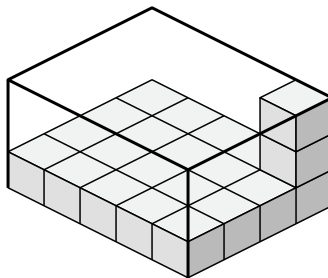

5)

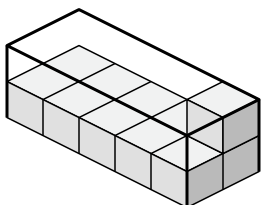

6)

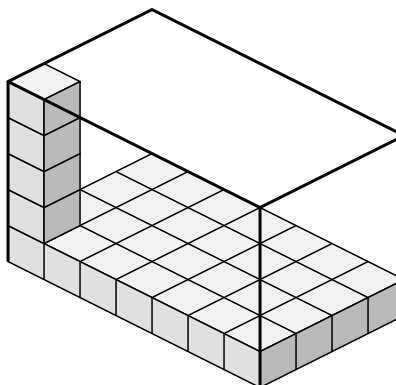

7)

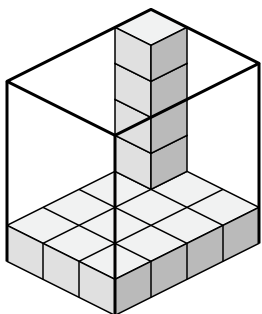

8)

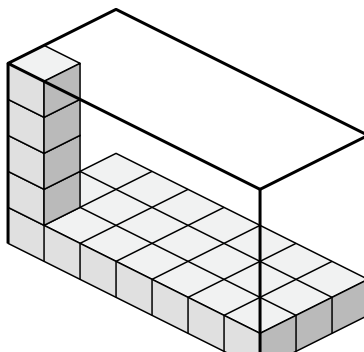

Answers

1. \_\_\_\_\_

2. \_\_\_\_\_

3. \_\_\_\_\_

4. \_\_\_\_\_

5. \_\_\_\_\_

6. \_\_\_\_\_

7. \_\_\_\_\_

8. \_\_\_\_\_



Create an expression to determine the volume of each box.

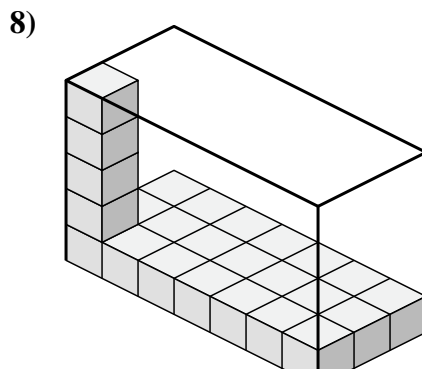
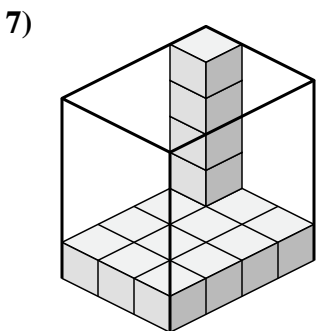
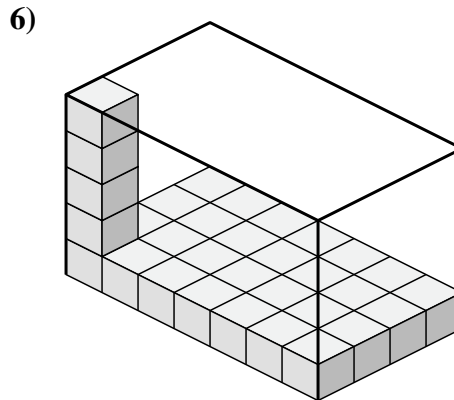
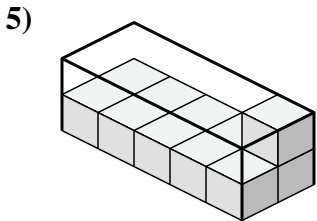
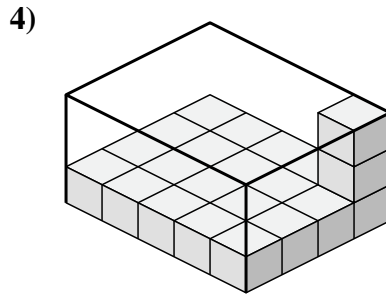
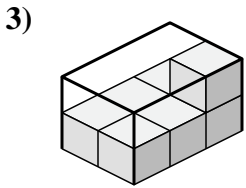
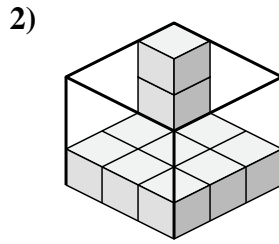
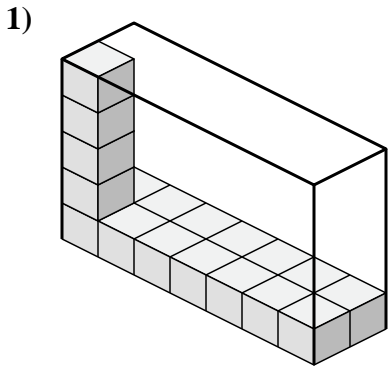

Answers

1. 7×2×5

2. 3×3×3

3. 2×3×2

4. 5×4×3

5. 5×2×2

6. 7×4×5

7. 3×4×5

8. 7×3×5