

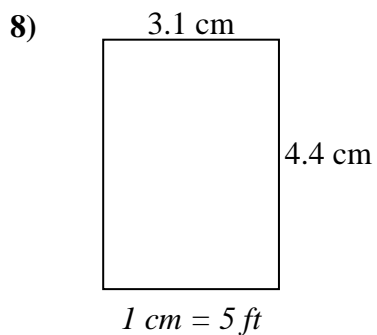

Determine the actual width, height and area of each scale rectangle.

Round the area to the nearest whole number.

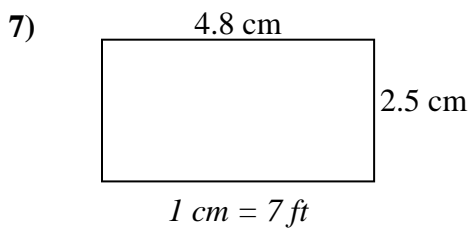
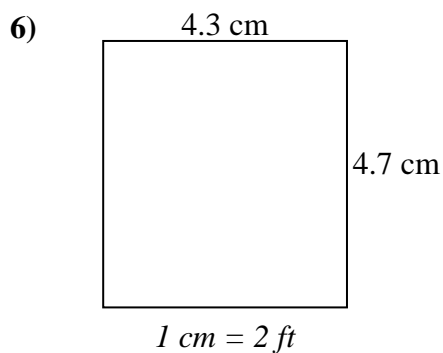
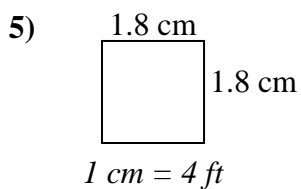
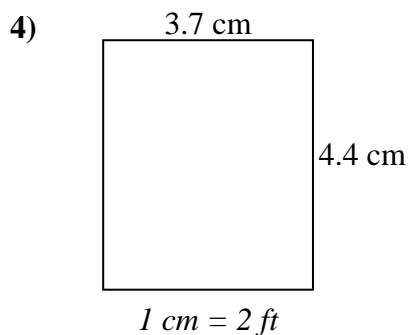
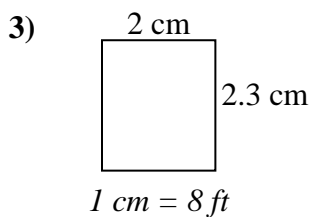
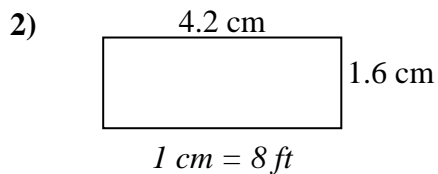
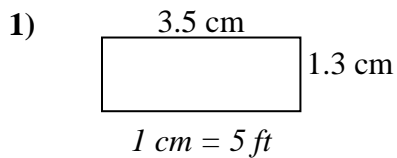

Answers

1. _____

2. _____

3. _____

4. _____

5. _____

6. _____

7. _____

8. _____



Determine the actual width, height and area of each scale rectangle.

Round the area to the nearest whole number.

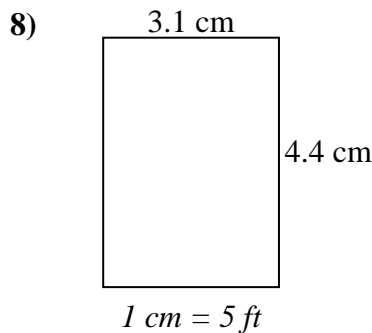
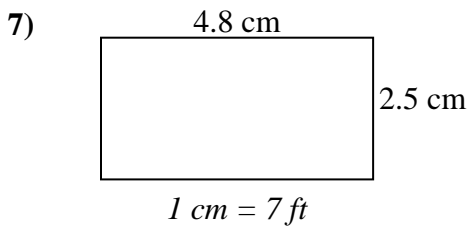
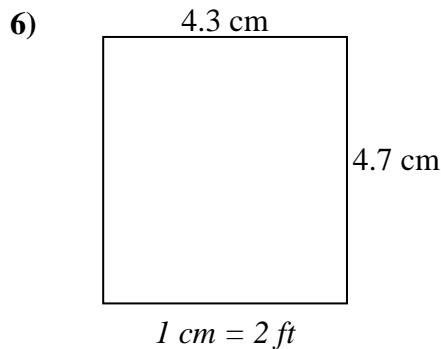
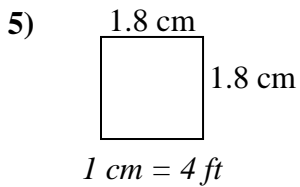
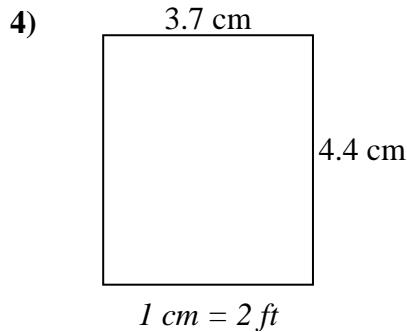
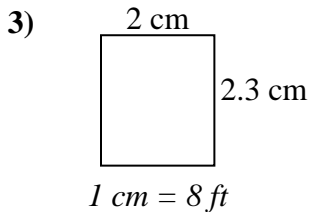
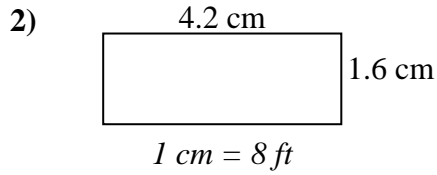
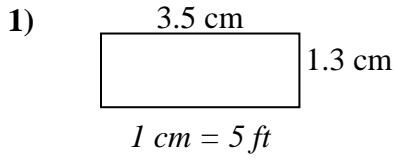

Answers

1. 17.5 6.5 114
2. 33.6 12.8 430
3. 16 18.4 294
4. 7.4 8.8 65
5. 7.2 7.2 52
6. 8.6 9.4 81
7. 33.6 17.5 588
8. 15.5 22 341